



verity[®]

4020 Single Syringe Pump
4120 Dual with Tee Syringe Pump
4220 Dual Syringe Pump

User's Guide



Gilson, Inc. | PO Box 620027 | Middleton, WI 53562-0027 | Tel: 608-836-1551 OR 800-445-7661 | Fax: 608-831-4451

Gilson S.A.S. | 19, avenue des Entrepreneurs | BP 145, F-95400 Villiers-le-bel, FRANCE

www.gilson.com | sales@gilson.com | service@gilson.com | training@gilson.com

LT310090-02

Table of Contents

Safety

Electronic and Hazard Symbols.....	2
Safety Notices	2
Voltage.....	3
Stacking Bracket.....	3
Solvents.....	3
Replacement Parts.....	3

Sécurité

Symboles Électroniques et de Dangers	6
Notes de Sécurité.....	6
Tension.....	7
Kit de superposition	7
Solvants.....	7
Pièces détachées	7

1 Introduction

Description.....	10
Unpacking	11
Standard Equipment.....	12
Accessories	12
Customer Service.....	13
Trademarks.....	13
Technical Specifications.....	14

2 Installation

Syringe Installation	18
Plumbing Connections	19
VERITY® 4020 Syringe Pump.....	19
VERITY® 4120 Syringe Pump.....	20
VERITY® 4220 Syringe Pump.....	21
Rear Panel Connections.....	23
Rear Panel Diagram	23
USB Device Port	23
Power Connection	23
Stacking Bracket Installation	24

3 Operation

Front Panel	26
Power Indicator Light	26
Error Indicator Light	26
Power Switch.....	26
Start Up.....	26
Prime the Syringe Pump	27
TRILUTION® LC.....	27
TRILUTION® LH.....	28

4 Maintenance

Helpful Hints	30
Cleaning	31
Exterior.....	31
Syringe.....	31
Valve	34
Tee.....	35
Part Replacement.....	36
Tubing	36
Syringe.....	36
Valve	38

5 Troubleshooting

Mechanical	40
Electrical	40
Hydraulic.....	40
Error Codes and Messages	42
TRILUTION® LC.....	42
TRILUTION® LH.....	42
Error Codes and Messages	43
Repair and Return Policies	44
Before Calling Us.....	44
Warranty Repair	44
Non-Warranty Repair.....	44
Return Procedure.....	44
Unit End-of-Life.....	44

A Replacement Parts and Accessories

Syringe Pumps	45
Syringes.....	45
Piston Seals.....	46
Valve and Valve Parts	46
Tubing	47
Inlet.....	47
Vent.....	47
Junction (for VERITY® 4120 Syringe Pump only)	47
Cables and Power Cords	47

B Materials

Liquid Contact Materials	49
--------------------------------	----

C Operational Description

VERITY® 4020 Single Syringe Pump.....	52
VERITY® 4120 Dual with Tee Syringe Pump.....	53
Aspirating from the Reservoir (Left Syringe Only)	53
Dispensing from the Left Syringe	54
Dispensing from the Right Syringe	55
Aspirating from the Probe (Left Syringe)	56
Aspirating from the Probe (Right Syringe)	57
VERITY® 4220 Dual Syringe Pump	58

Safety

Read this chapter before installing and operating the instrument.







Only trained technical personnel in a laboratory environment may use the instrument for non-medical, liquid handling purposes. For safe and correct use of the instrument, operating and service personnel must follow all instructions contained in this guide when installing, cleaning, and maintaining the instrument. All safety precautions must be observed during all phases of operation, service, and repair of the instrument.

Failure to comply with these precautions or with warnings described in the user's guide violates safety standards of design, manufacture, and intended use of the instrument. Gilson assumes no liability for customers failing to comply with these requirements.

The instrument has been certified to safety standards required in Canada, Europe, and the United States. Refer to the rear panel label on the instrument and the Declaration of Conformity document for the current standards to which the instrument has been found compliant.



Electronic and Hazard Symbols

The following electronic and hazard symbols may appear on the instrument:

Symbol	Explanation
	Direct current Courant continu Gleichstrom
	Protective conductor terminal Borne de terre de protection Schutzleiteranschluss
	Electrical power ON Sous tension Netzschalter ein
	Electrical power OFF Hors tension Netzschalter aus
	Caution Attention Vorsicht
	Caution, risk of electric shock Attention, risque de choc électrique Vorsicht, Elektroschockgefahr
	Caution, hot surface Attention, surface chaude Vorsicht, heiße Oberfläche

Safety Notices

The following safety notices may appear in this document:

 WARNING	WARNING indicates a potentially hazardous situation which, if not avoided, may result in serious injury
 CAUTION	CAUTION indicates a potentially hazardous situation which, if not avoided, may result in minor or moderate injury
NOTICE	NOTICE indicates a potentially hazardous situation which, if not avoided, may result in equipment damage

Voltage

Ensure that the rear panel is easily accessible. Detach all sources of voltage from the instrument before the service, repair, or exchange of parts. Use only the grounded AC cord provided. Ungrounded power cords can result in electrical shock and serious personal injury. Use only approved fuses with the specified current rating. The instrument must be operated within the voltage specified on the rear panel of the instrument.

Stacking Bracket

The supplied stacking bracket must be used to prevent tipping when stacking two syringe pumps. Do not stack more than one pump on top of another pump. The stacking bracket stabilizes the pump stack by anchoring it to the GX-274 Liquid Handler.

Solvents

Observe safe laboratory practices when handling solvents. Adequate safety precautions, such as proper ventilation, safety glasses, etc., must be used when handling dangerous liquids. Refer to the Material Safety Data Sheet (MSDS) for each solvent before use.

Replacement Parts

Only use the replacement parts mentioned in this user's guide.

Sécurité

Merci de lire attentivement cette section avant toute installation ou utilisation de l'instrument.







Cet instrument est exclusivement destiné à être utilisé dans un environnement de laboratoire, par un personnel qualifié, à des fins de manipulations de liquides non-médicales. Pour une utilisation correcte et en toute sécurité de l'instrument, il est nécessaire que le personnel qui utilise et réalise la maintenance de l'instrument, suive les instructions contenues dans ce guide lors de l'installation, du nettoyage et de la maintenance de l'instrument. Toutes les consignes de sécurité doivent être respectées durant toutes les phases de fonctionnement, d'entretien ou de réparation de l'instrument.

Le non-respect de ces précautions ou des avertissements spécifiques mentionnés dans ce guide compromet les normes de sécurité de conception, de fabrication et d'utilisation prévue de l'instrument. Gilson décline toute responsabilité en cas d'incapacité du client à se conformer à ces exigences.

L'instrument a été certifié conformément aux normes de sécurité en vigueur au Canada, en Europe et aux États-Unis. Merci de vous reporter aux indications mentionnées sur le panneau arrière de l'instrument ainsi qu'au document de Déclaration de Conformité aux normes pour lesquelles l'instrument a été déclaré conforme.



Symboles Électroniques et de Dangers

Les symboles électroniques et de dangers suivants peuvent apparaître sur l'instrument:

Symbol	Explanation
	Direct current Courant continu Gleichstrom
	Protective conductor terminal Borne de terre de protection Schutzleiteranschluss
	Electrical power ON Sous tension Netzschalter ein
	Electrical power OFF Hors tension Netzschalter aus
	Caution Attention Vorsicht
	Caution, risk of electric shock Attention, risque de choc électrique Vorsicht, Elektroschockgefahr
	Caution, hot surface Attention, surface chaude Vorsicht, heiße Oberfläche

Notes de Sécurité

Les notes de sécurité suivantes peuvent apparaître dans ce document:

 WARNING	WARNING indique une situation potentiellement dangereuse qui, si elle n'est pas évitée, peut entraîner des blessures graves
 CAUTION	CAUTION indique une situation potentiellement dangereuse qui, si elle n'est pas évitée, peut entraîner des blessures mineures à modérées
 NOTICE	NOTICE indique une situation potentiellement dangereuse qui, si elle n'est pas évitée, peut entraîner des dégâts matériels

Tension

S'assurer que l'accès au panneau arrière est libre. Déconnecter la source d'alimentation avant toute opération d'entretien, de réparation ou de remplacement de pièces. Utiliser exclusivement le bloc et le cordon d'alimentation avec raccordement à la terre fournis. Un cordon d'alimentation sans terre peut provoquer choc électrique et graves blessures. Utiliser exclusivement des fusibles de l'intensité et du type spécifié. Pour le fonctionnement, respecter la tension indiquée sur le panneau arrière de l'instrument.

Kit de superposition

Le kit de superposition fourni doit être utilisé afin d'éviter tout risque de basculement lors de l'empilage de deux pompes bi-seringues VERITY® 4220. Ne pas empiler plus de 2 pompes. Le kit de superposition doit être fixé au GX-274 ASPEC™.

Solvants

Respecter les Bonnes Pratiques de Laboratoire lors de la manipulation de solvants. Si des liquides dangereux sont utilisés, s'assurer que la ventilation est adéquate et porter en permanence un équipement de protection individuelle (EPI), tel que : lunettes, gants et vêtements de protection. Se reporter aux Fiches de Données de Sécurité relatives aux solvants avant toute utilisation.

Pièces détachées

Utiliser exclusivement les pièces détachées mentionnées dans le guide de l'utilisateur.

Introduction

Chapter One

This chapter provides information on the following topics:

- [Description](#) on page 10
- [Unpacking](#) on page 11
- [Customer Service](#) on page 13
- [Trademarks](#) on page 13
- [Technical Specifications](#) on page 14

Description

The VERITY® 4020 Single, VERITY® 4120 Dual with Tee, and VERITY® 4220 Dual Syringe Pumps, when paired with a Gilson liquid handler, can automate liquid handling procedures.

- The VERITY® 4020 Single Syringe Pump is equipped with a user-selectable, small- or large-capacity syringe and a valve for directing liquid from reservoir or probe.
- The VERITY® 4120 Dual with Tee Syringe Pump is equipped with two syringes that are user-selectable. The capacity of the left syringe must be greater than or equal to the right syringe. The instrument includes one valve to direct liquid from reservoir or probe (on the left) and a tee connected via junction tubing (on the right).
- The VERITY® 4220 Dual Syringe Pump is equipped with up to two syringes that are user-selectable, can be the same or different, and can be a small- or large-capacity. Two valves direct liquid from reservoirs or up to two probes. When two VERITY® 4220 Dual Syringe Pumps are used with a GX-274 Liquid Handler, up to four fluid paths can be controlled independently, which allows for a high throughput configuration capable of processing up to four samples in parallel.

The VERITY® 4020 Single, VERITY® 4120 Dual with Tee, and VERITY® 4220 Dual Syringe Pumps assure accuracy in sample transfers, dilutions, reagent additions, mixing, and other liquid handling tasks. They offer speed and reliability for liquid handling tasks.



Figure 1: VERITY® 4020 Single, VERITY® 4120 Dual with Tee, and VERITY® 4220 Dual Syringe Pumps

Unpacking

The syringe pump(s) are delivered with most major components already assembled. Keep the original container and packing assembly in case the syringe pump(s) must be returned to the factory.

To unpack each syringe pump:

1. Open the box and then remove the bag of documents inside.
2. Lift the syringe pump and foam inserts out of the box, and then remove the foam inserts.
3. Remove the cardboard insert (and cardboard spacer, if applicable) containing the accessories and the power supply.
4. Remove the bag covering the syringe pump.

The liquid handler and other accessories (syringes, probes, racks, etc.) are ordered and packaged separately.

Standard Equipment

Once the syringe pump and the accessories have been unpacked, you should have the following:

- VERITY® 4020 Single Syringe Pump, VERITY® 4120 Dual with Tee Syringe Pump, or VERITY® 4220 Dual Syringe Pump
- Accessory Kit that includes:
 - Inlet Tubing with Filter Assembly and 1/4"-28 Coupling
 - Junction Tubing (VERITY® 4120 Dual with Tee Syringe Pump configuration only)
 - Power Cords
 - USB Cable
 - Valve Key
 - Vent Tubing
- Power Supply

Documentation

The following documents are included with the syringe pump:

- Declaration of Conformity
- Hazardous Materials Declaration (China RoHS)
- Installation Qualification (IQ) procedure
- Items Included Checklist
- Quality Control (QC) checklist

This user's guide and IQ procedure document are provided on the *VERITY® 4X20 Syringe Pumps Documentation CD*.

Accessories

Required

Some accessories are required, but are ordered separately:

- Syringe(s)
- Transfer Tubing (refer to the liquid handler user's guide for part numbers)

Customer Service

Gilson, Inc. and its worldwide network of representatives provide customers with the following types of assistance: sales, technical support, applications, and instrument repair.

If you need assistance, please contact your local Gilson representative. Specific contact information can be found at www.gilson.com. To help us serve you quickly and efficiently, please refer to [Before Calling Us](#) on page 44.

Trademarks

The following trademark may appear in this document:

- Ekonol® is a registered trademark of Saint Gobain Advanced Ceramics LLC.
- Teflon® is a registered trademark of E.I. du Pont de Nemours & Co, Inc.

Technical Specifications

Please be aware of the following before operating the instrument.

NOTICE

Changes or modifications to the instrument not expressly approved by Gilson could void the factory-authorized warranty.

This instrument complies with part 15 of the FCC Rules. Operation is subject to the following two conditions: (1) this instrument may not cause harmful interference, and (2) this instrument must accept any interference received, including interference that may cause undesired operation.

Shielded cables must be used with the instrument to ensure compliance with the FCC Class A limits.

VERITY® 4020 Single, VERITY® 4120 Dual with Tee, and VERITY® 4220 Dual Syringe Pumps

Technical Specification	Definition	
Communication	USB	
Dimensions (W x D x H)	VERITY® 4020 Single Syringe Pump 14.6 x 17.1 x 26.9 cm (5.8 x 6.7 x 10.6 in.)	
	VERITY® 4120 Dual with Tee Syringe Pump and VERITY® 4220 Dual Syringe Pump 22.6 x 17.1 x 26.9 cm (8.9 x 6.7 x 10.6 in.)	
Environmental Conditions	<ul style="list-style-type: none"> • Indoor use • Altitude: up to 2000 m • Temperature range: 5°C–40°C • Humidity: Maximum relative humidity 80% for temperatures up to 31°C, decreasing linearly to 50% relative humidity at 40°C 	
Front Panel	Indicator lights for power and error	
Liquid Contact Materials* <small>*For more information, refer to the Materials appendix.</small>	Description	Material
	Syringe	Glass PTFE Ekonal
	Syringe Valve	PEEK Ceramic PTFE
	Tee	PEEK
	Junction Tubing and Union Connectors	FEP PEEK

VERITY® 4020 Single, VERITY® 4120 Dual with Tee, and VERITY® 4220 Dual Syringe Pumps Technical Specifications
(continued on page 15)

VERITY® 4020 Single, VERITY® 4120 Dual with Tee, and VERITY® 4220 Dual Syringe Pumps

<i>Technical Specification</i>	<i>Definition</i>	
Maximum Syringe Flow Rate for Water	<i>Syringe Size</i>	<i>Recommended Maximum Flow Rate</i>
	100 µL	4 mL/min
	250 µL	10 mL/min
	500 µL	20 mL/min
	1 mL	40 mL/min
	5 mL	100 mL/min
	10 mL	100 mL/min
	25 mL	100 mL/min
Power Requirements	VERITY® 4020 Single Syringe Pump Voltage: 24V DC Current Rating: 1A, 24W	
	VERITY® 4120 Dual with Tee Syringe Pump and VERITY® 4220 Dual Syringe Pump Voltage: 24V DC Current Rating: 2A, 48W	
	External Power Supply Voltage Input Frequency: 50 to 60 Hz Voltage: 100–240V AC Voltage Output Voltage: 24V DC Current Rating: 2.5A, 60W	
Precision (Calculated as Coefficient of Variation)	1%	
Safety and Compliance	The instrument has been certified to safety standards specified for Canada, Europe, and the United States. Refer to the instrument rear panel label and the Declaration of Conformity document for the current standards to which the instrument has been found compliant.	
Syringe Capacity	100 µL, 250 µL, 500 µL, 1 mL, 5 mL, 10 mL, or 25 mL	
Software Control	PC control via USB and TRILUTION® LH or TRILUTION® LC Software	

*VERITY® 4020 Single, VERITY® 4120 Dual with Tee, and VERITY® 4220 Dual Syringe Pumps Technical Specifications
(continued on page 16)*

VERITY® 4020 Single, VERITY® 4120 Dual with Tee, and VERITY® 4220 Dual Syringe Pumps

Technical Specification	Definition
Tee	Type: Three port, no moving parts Diameter of channels: 1.5 mm Length of channels: 14 mm Angle between channels: 120° Liquid contact material: PEEK Dead volume: 51 µL
Valve	Type: Three port, two position Angle between ports: 120° Valve drive: Stepper motor Rotation time: 0.5 seconds Liquid contact materials: PEEK and ceramic Dead volume: 123 µL Maximum Pressure: 0.8 MPa
Volumetric Accuracy* (Calculated as Systematic Error) <small>*Contact techsupport@gilson.com to learn what methods and conditions were used to obtain the values.</small>	±2% (10%–90% syringe capacity, water)
Weight	VERITY® 4020 Single Syringe Pump 4.4 kg (9.7 lbs.)
	VERITY® 4120 Dual with Tee Syringe Pump 6.8 kg (15.0 lbs.)
	VERITY® 4220 Dual Syringe Pump 7.1 kg (15.7 lbs.)

Installation

Chapter Two

This chapter provides information on the following topics:

- [Syringe Installation](#) on page 18
- [Plumbing Connections](#) on page 19
- [Rear Panel Connections](#) on page 23
- [Stacking Bracket Installation](#) on page 24

It is recommended to set up the liquid handler before setting up the syringe pump. For instructions, refer to the documentation supplied with the liquid handler.

Syringe Installation

CAUTION

To prevent injury, when operating the syringe pump, keep hands clear of syringe to avoid risk of personal injury by pinching.

The 100 μ L, 250 μ L and 500 μ L syringes are supplied with a cover seal to ensure an airtight fit between the syringe and the valve.

Before mounting one of the smaller syringes (100 μ L, 250 μ L, 500 μ L and 1 mL), manually prime it. Place its open end in the pump reservoir and use the piston to aspirate the liquid. This manual prime is not necessary for the 5 mL, 10 mL, and 25 mL syringes.

The piston operating rod will be shipped in the down position. If the rod is not in the down position, refer to the instructions for replacing a syringe on page 32, which explain how to lower the rod.

The following procedure is important for correct syringe piston alignment. Improper alignment may cause premature piston failure.

1. Remove the valve from the front panel by removing the two securing valve screws.
2. Lubricate the piston with an alcohol-based solvent (methanol, for example) to reduce piston seal friction during syringe installation.
3. Remove the cap covering the port where the syringe connects to the valve, and then loosely screw the syringe into the valve. Do not fully tighten.
4. Loosely attach the valve to the syringe pump with the supplied screws.
5. Pull down the piston so it comes into contact with the piston operating rod, and firmly tighten the piston holding screw.
6. Fully tighten the valve screws to secure the valve.
7. Fully tighten the syringe to the valve.

Remember or note the size of the syringe installed for later software configuration.

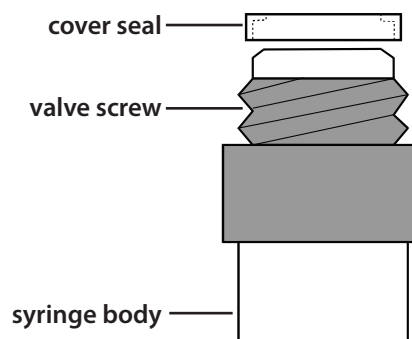

Figure 2: Cover Seal on Syringe

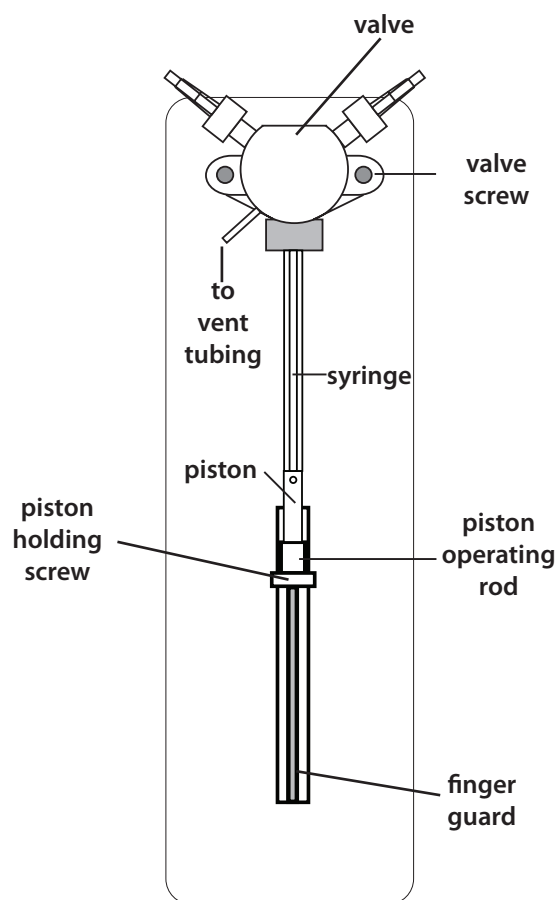

Figure 3: Syringe Installation

Plumbing Connections

After setting up the liquid handler and installing the syringe(s), make the plumbing connections as described on the following pages:

- **VERITY® 4020 Syringe Pump** on page 19
- **VERITY® 4120 Syringe Pump** on page 20
- **VERITY® 4220 Syringe Pump** on page 21

VERITY® 4020 Syringe Pump

The syringe pump is shipped with a plug in each port. Remove the plugs before connecting any tubing.

Inlet

The inlet tubing connects the valve inlet to the solvent reservoir. One single length of inlet tubing is supplied.

This tubing is used to connect the inlet of the valve to a liquid reservoir. There is a PEEK fitting at one end of the tubing and a 20 µm filter on the other end.

Screw the PEEK fitting into the inlet, and then put the end with the filter attached into the appropriate liquid reservoir.

Vent

The valve releases liquid through the vent if the pressure inside the valve is too high. For the pressure limits of the valve, refer to the technical specifications for the valve.

Attach the vent tubing to its port on the valve and then place the other end in suitable waste receptacle.

Transfer

Transfer tubing and fittings are ordered and supplied with the liquid handler.

Use transfer tubing to connect the transfer tubing side of the syringe valve to the probe on the liquid handler. Remember to leave enough tubing to account for movement of the probe.

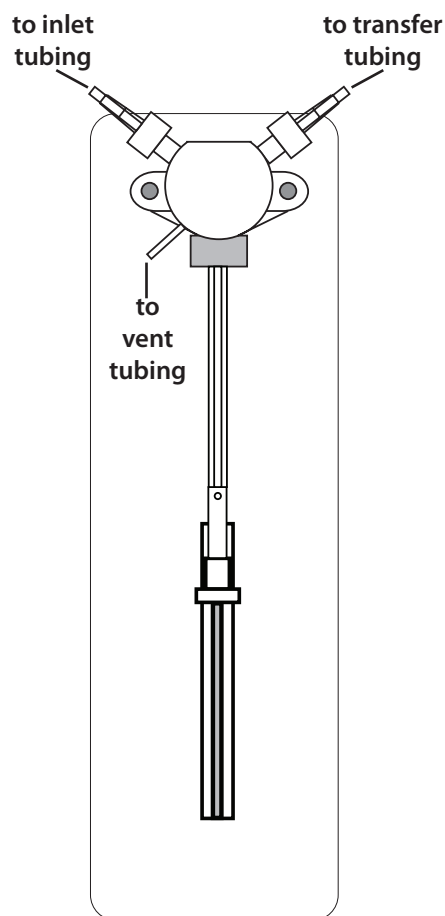

Figure 4: Tubing Connections

VERITY® 4120 Syringe Pump

The syringe pump is shipped with a plug in each port. Remove the plugs before connecting any tubing.

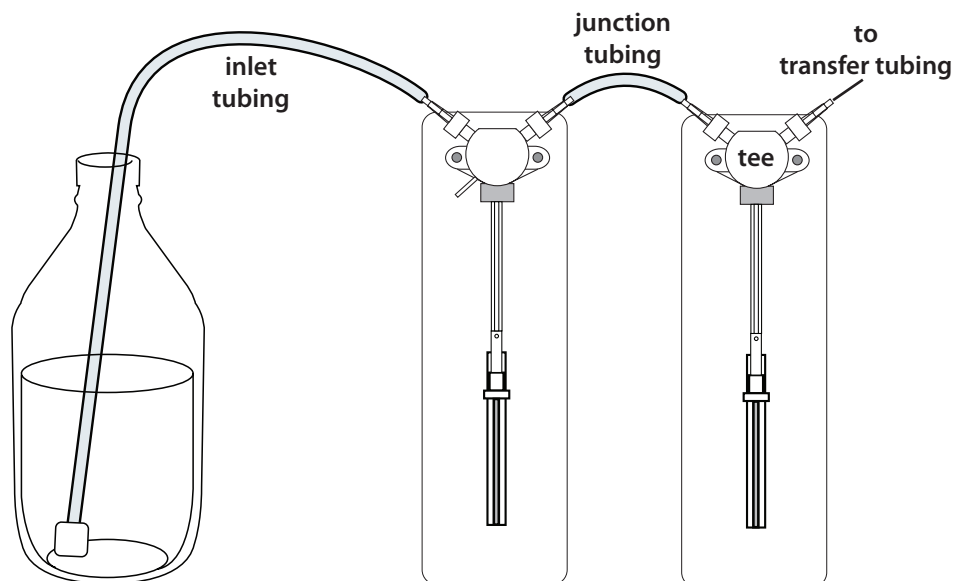

Figure 5: Tubing Connections - VERITY® 4120 Dual with Tee Syringe Pump

Valve Inlet

The inlet tubing connects the valve inlet to the solvent reservoir. One single length of inlet tubing is supplied. This tubing is used to connect the inlet of the valve to a liquid reservoir. There is a PEEK fitting at one end of the tubing and a 20 μ m filter on the other end. Screw the PEEK fitting into the inlet and then put the end with the filter attached into the appropriate liquid reservoir.

Valve Vent

The valve releases liquid through the vent if the pressure inside the valve is too high. For the pressure limits of the valve, refer to the technical specifications for the valve.

Attach the vent tubing to its port on the valve and then place the other end in suitable waste receptacle.

Junction Tubing

The connection tubing connects the valve outlet to the tee inlet. It is supplied in two sizes: .030" (0.8 mm) ID and .080" (2.0 mm) ID.

There is a PEEK fitting at each end of the tubing. Install the .030" (0.8 mm) ID connection tubing if the inner diameter of the transfer tubing used is .030" (0.8 mm) or smaller. Install the .080" (2.0 mm) ID connection tubing if the inner diameter of the transfer tubing used is greater than .080" (2.0 mm).

Tee Outlet

Transfer tubing and fittings are ordered and supplied with the liquid handler. Use transfer tubing to connect the transfer tubing side of the syringe valve to the probe on the liquid handler. Remember to leave enough tubing to account for movement of the probe.

VERITY® 4220 Syringe Pump

The syringe pump is shipped with a plug in each port. Remove the plugs before connecting any tubing.

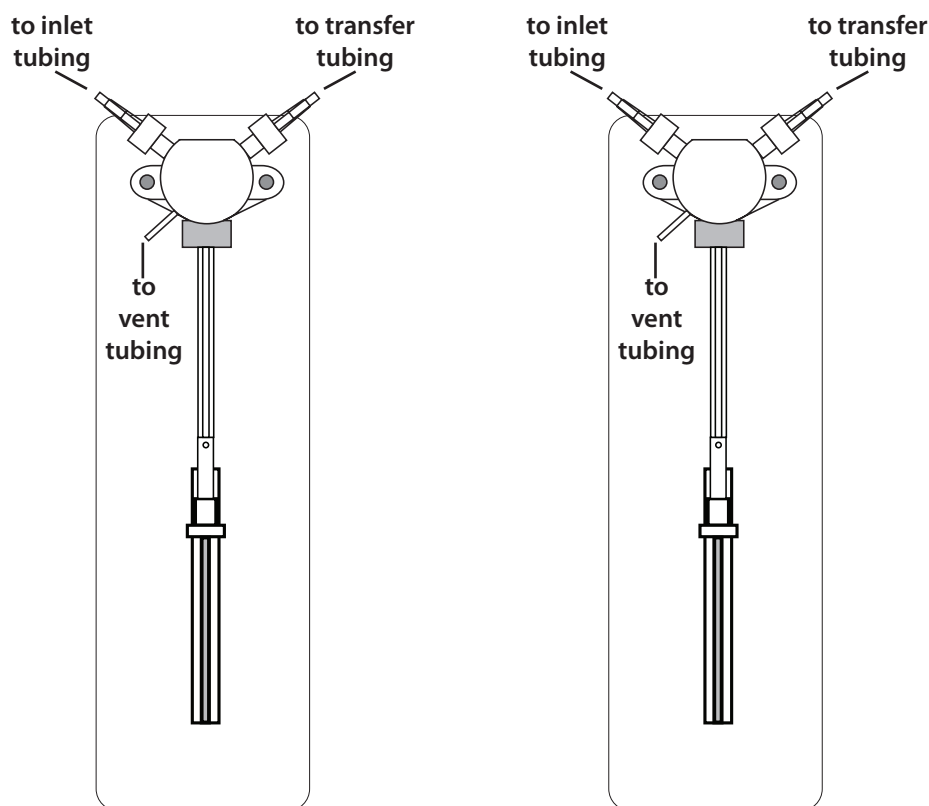

Figure 6: Tubing Connections - VERITY® 4220 Dual Syringe Pump

Inlet

The inlet tubing connects the valve inlet to the solvent reservoir. Two inlet tubing assemblies are provided with the VERITY® 4220 Syringe Pump. This tubing is used to connect the inlet of each valve to a liquid reservoir. There is a PEEK fitting at one end of the tubing and a 20 µm filter on the other end. Screw the PEEK fitting into the inlet, and then put the end with the filter attached into the appropriate liquid reservoir.

Vent

The valve releases liquid through the vent if the pressure inside the valve is too high. For the pressure limits of the valve, refer to the technical specifications for the valve. Two pieces of vent tubing are provided with the VERITY® 4220 Dual Syringe Pump.

Attach the vent tubing to its port on the valve and then place the other end in suitable waste receptacle.

Transfer

Transfer tubing and fittings are ordered and supplied with the liquid handler. Use transfer tubing to connect the transfer tubing side of each syringe valve to a probe on the liquid handler. Remember to leave enough tubing to account for movement of the probe.

VERITY® 4220 Dual Syringe Pump to Single Probe Liquid Handler Configuration

The outlet of both valves may be connected to a single probe via a tee (ordered separately, part number 4957713).

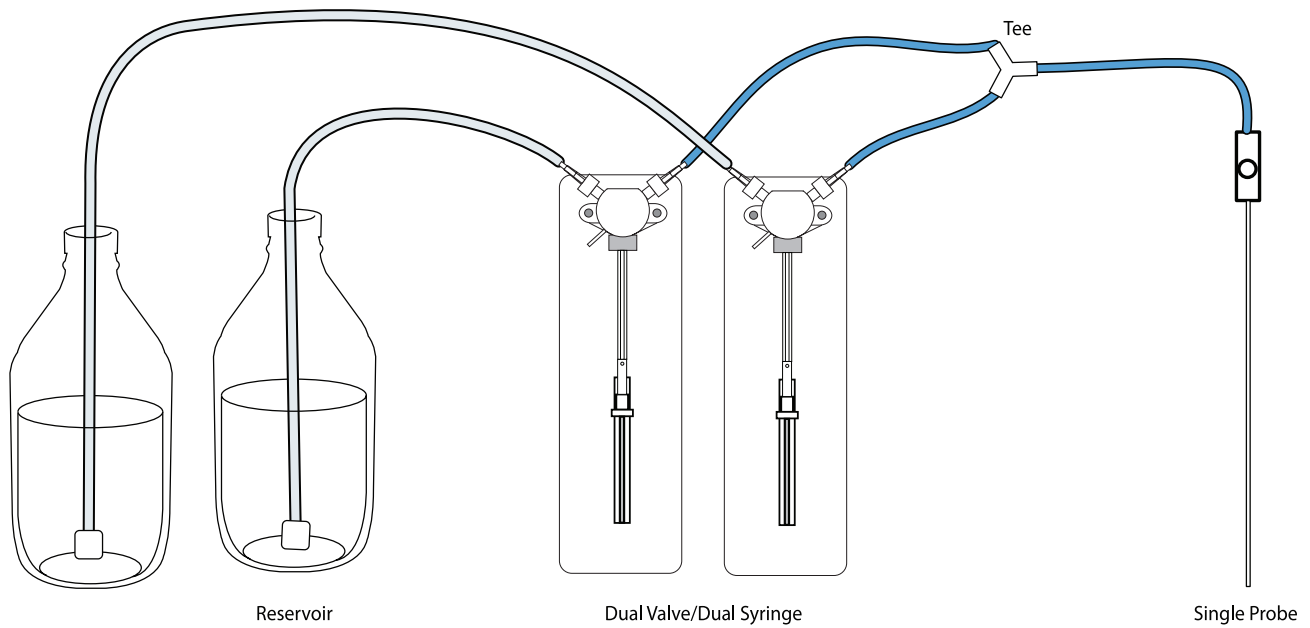

Figure 7: Tubing Connections - VERITY® 4220 Dual Syringe Pump to Single Probe Liquid Handler

Rear Panel Connections

Rear Panel Diagram

- ① USB device port
- ② Power receptacle

USB Device Port

The syringe pump communicates with a standard PC via USB.

To make the USB connection between the syringe pump and the controlling device (PC), use the USB cable (part number 32000012) supplied in the accessory kit. Use the end with the “A-type” (flat) connector to connect to the controlling device and use the end with the “B-type” (square) connector to connect to the syringe pump.

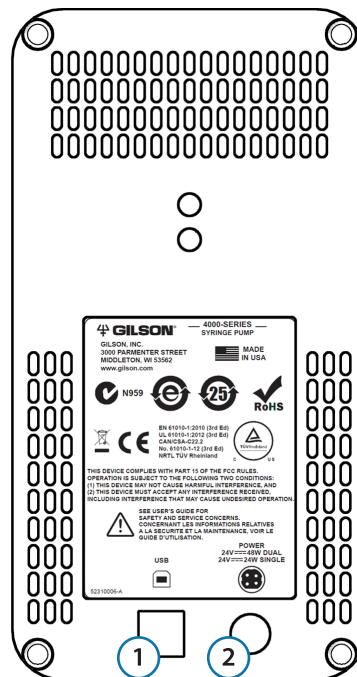

Figure 8: Rear Panel Diagram - VERITY® 4020 Single Syringe Pump

Power Connection

Use the power cord on the external power supply to make the connection between the power receptacle on the syringe pump and the external power supply.

The connection from the external power supply to the syringe pump uses a connector with a locking collar. Check the alignment of the pins and then push it in until it clicks and locks in place. To disconnect, pull back on the locking collar and then disconnect the cable from the rear panel of the syringe pump.

Locate the appropriate power cord for your line voltage and then make the connection between the external power supply and the AC power source.

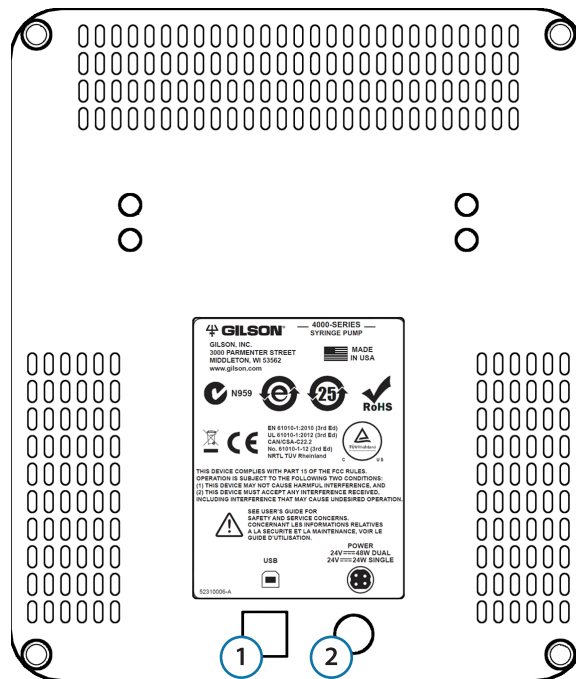

Figure 9: Rear Panel Diagram - VERITY® 4120 Dual with Tee Syringe Pump and VERITY® 4220 Dual Syringe Pump

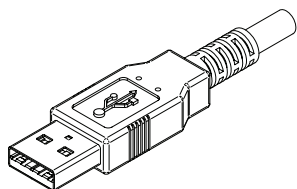

Figure 10: USB Cable with “A-Type” Connector

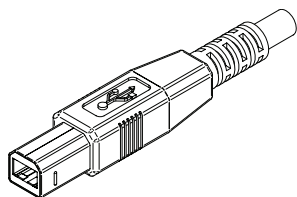

Figure 11: USB Cable with “B-Type” Connector

Stacking Bracket Installation

The supplied stacking bracket kit (part number 31030018) must be used to prevent tipping when stacking two VERITY® 4220 Dual Syringe Pumps. Do not stack more than one pump on top of another pump. The stacking bracket stabilizes the pump stack by anchoring it to the GX-274 Liquid Handler.

The following items will be included with the stacking bracket kit:

- Stacking bracket
- Two hex screws
- Two rubber spacers (pre-installed)
- One metal spacer

To install the stacking bracket:

1. Thread a hex screw through the top hole in the stacking bracket and through the 0.175" metal spacer.
2. Insert the screw and threaded components into the top hole of the left support on the GX-274 Liquid Handler. Loosely tighten the top screw.
3. Insert the other screw through the stacking bracket into the bottom hole of the left support on the GX-274 Liquid Handler. Fully tighten the screw.
4. Fully tighten the top screw.
5. Slide one of the VERITY® 4220 Dual Syringe Pumps under the installed bracket.
6. Set the second VERITY® 4220 Dual Syringe Pump on top of the first, threading the back support feet through the holes on the stacking bracket.

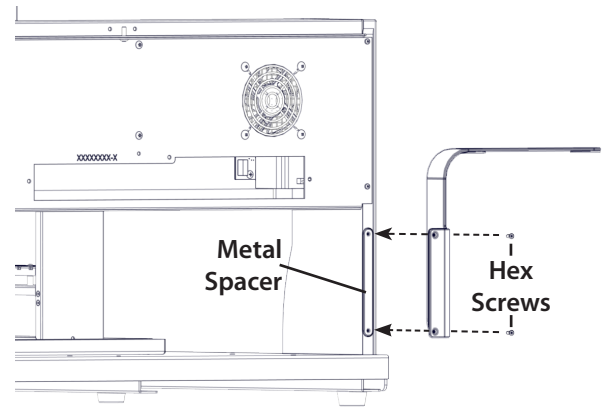
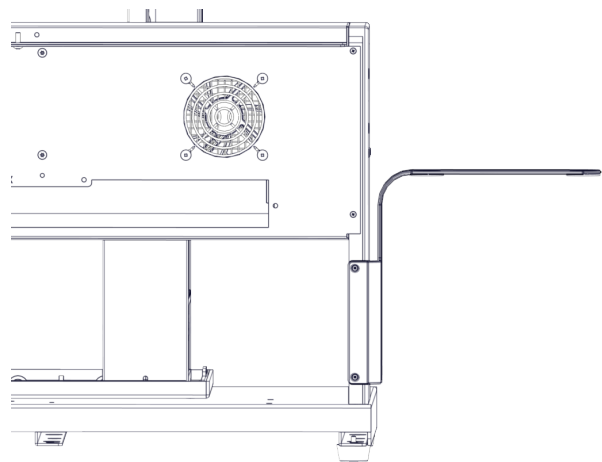
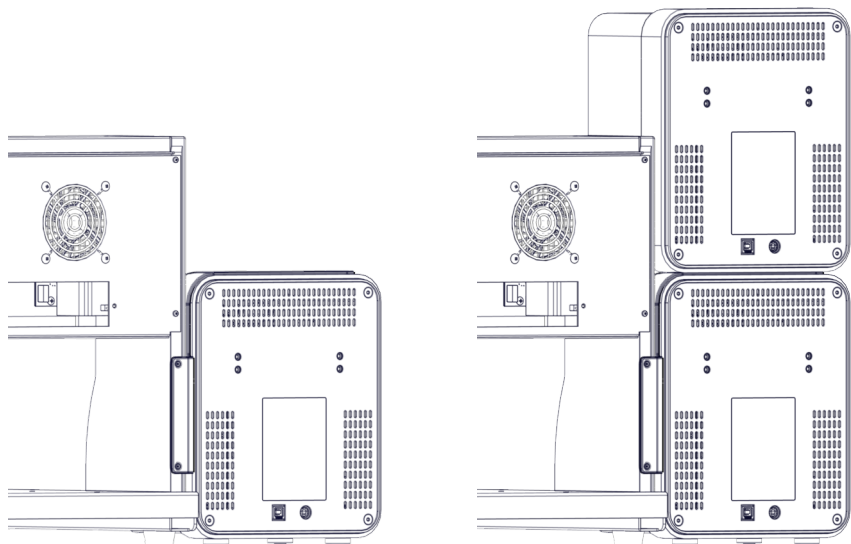

Figure 12: Stacking Bracket and Components (Rear View)



Steps 1 to 4



Step 5

Step 6

Operation

Chapter Three

Install TRILUTION® LC v3.0 and Service Pack 5 (or higher) or TRILUTION® LH v3.0 Software and Service Pack 3 (or higher) per the installation guide included with the software and the instructions provided with the service pack. These software packages provide control of the VERITY® 4020 Single, VERITY® 4120 Dual with Tee, and VERITY® 4220 Dual Syringe Pumps. For more information about TRILUTION LC or TRILUTION LH software, refer to the respective user's guide and documentation supplied with the software.

This chapter provides information on the following topics:

- **Front Panel** on page 26
- **Start Up** on page 26
- **Prime the Syringe Pump** on page 27

Front Panel

The front panel includes a power indicator light and an error indicator light.

- ① Power Indicator Light
- ② Error Indicator Light

Power Indicator Light

The green indicator becomes lit when power to the syringe pump is switched on.

Error Indicator Light

The red indicator light flashes when an error has been encountered.

Side Panel

The side panel includes the power switch.

- ③ Power Switch

Power Switch

| indicates that the electrical power is switched on.

O indicates that the electrical power is switched off.

Start Up

To start the syringe pump:

1. Turn on power to the syringe pump using the switch on the side panel.
 - The power indicator light on the syringe pump front panel illuminates.
 - The syringe pump initializes. It stops with the valve set to the outlet (transfer tubing) position.
2. Start TRILUTION® LC or TRILUTION® LH software.

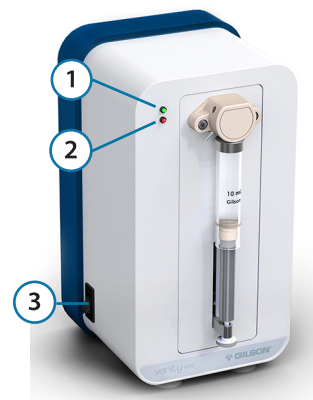

Figure 13: Front/Side Panel Diagram - VERITY® 4020 Single Syringe Pump



Figure 14: Front/Side Panel Diagram - VERITY® 4120 Dual with Tee Syringe Pump





Figure 15: Front/Side Panel Diagram - VERITY® 4220 Dual Syringe Pump

Prime the Syringe Pump

It is recommended to prime the syringe pump with liquid before using it the first time, or if it has not been used for some time.

TRILUTION® LC

The following procedures use TRILUTION LC software.

1. Open a method with a VERITY 4020 Syringe Pump, VERITY 4120 Syringe Pump, or VERITY 4220 Syringe Pump in the configuration.
2. Click **Run**.
3. Select a method under Method Configuration that includes the VERITY 4020 Syringe Pump, VERITY 4120 Syringe Pump, or VERITY 4220 Syringe Pump, and then click .
4. Click  to access the Manual Control window.
5. Click , enter or select a value for each property, and then click **OK** to aspirate the syringe capacity from the reservoir and then dispense to the specified well in the specified zone for the number of cycles.

NOTICE

TRILUTION LC does not validate any values or check for safe movement in manual control. Verify entries before clicking any buttons.

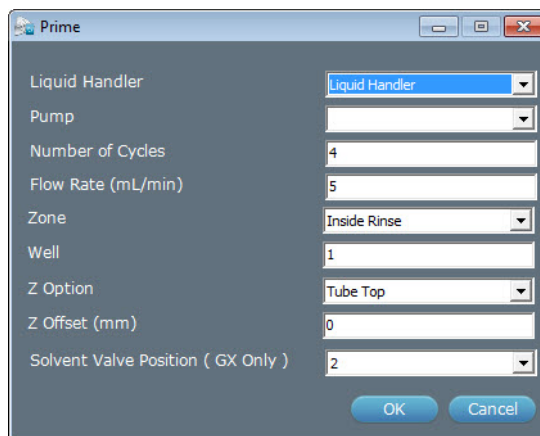

Figure 16: Manual Control - Prime

TRILUTION® LH

The following procedures use TRILUTION LH software.

1. Open a method with a VERITY 4020 Syringe Pump, VERITY 4120 Syringe Pump, or VERITY 4220 Syringe Pump in the configuration.
2. Click **Run**.
3. Add the method to the sample list.
4. Select the Manual Control tab.
5. Select the method from the drop-down list of methods and then click **Go**. The instruments will initialize.
6. If using a VERITY® 4220 Dual Syringe Pump, select the syringe(s) that will be used (Left Syringe and/or Right Syringe).
7. Enter a value for Prime Flow Rate. This is the speed at which reservoir fluid moves into and out of the syringe.

NOTICE

TRILUTION LH does not validate any values or check for safe movement in manual control. Verify entries before clicking any buttons.

8. Click **Prime** to start priming.
9. Click **Stop Prime** to end priming.

Maintenance

Chapter Four

When performing the maintenance described in this chapter, use good laboratory practice, including, but not limited to, wearing protective clothing and preparing the maintenance space for service. After completing the maintenance operation, verify the safe and good working order of the part and instrument.

This chapter contains the following information for maintaining the syringe pump:

- [Helpful Hints](#) on page 30
- [Cleaning](#) on page 31
- [Part Replacement](#) on page 36

Helpful Hints

To keep the syringe pump at optimal performance, Gilson recommends the following:

- Change or clean the piston seals and tubing regularly to maintain maximum performance.
- Do not cycle the syringe pump without fluid. Doing this causes excessive piston seal wear.
- Flush the syringe pump daily with distilled or deionized water. On a weekly basis, flush with a 10% solution of bleach or weak detergent.
- If bubbles remain in the syringes after priming, clean the syringes with alcohol.
- Check periodically to ensure that all fittings are tight.
- Check that each syringe is tight in the syringe pump valve.
- Clean the valve if the system has not been used for a while.
- Allow fluids to equilibrate to room temperature before running them through the system; cold fluids may cause leakage.

Cleaning

Exterior

Clean the instrument occasionally using a clean, dry cloth or, if necessary, use a cloth dipped in soapy water. If liquid is accidentally spilled on the instrument, wipe it using a dry, clean cloth.

Syringe

Clean a syringe when some or all of the following occurs:

- Corrosive or hazardous liquids have been pumped
- Possible back flow of liquids into the vent tubing
- Leakage
- Aspiration of samples or reagents into the syringe

To clean a syringe, follow the procedures in this section and use the diagram as a reference.

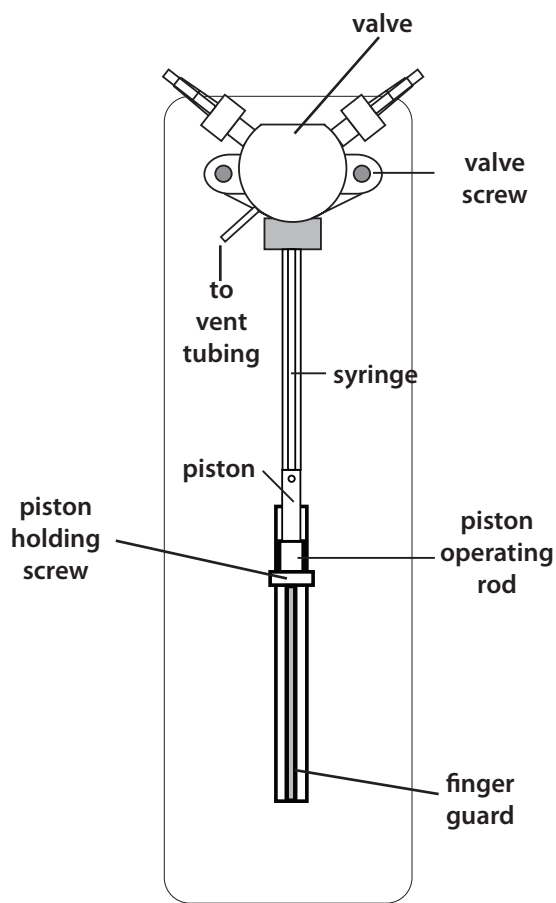



Figure 16: Syringe Diagram

Remove the Syringe

TRILUTION® LC

The following procedures use TRILUTION LC software.

1. Open a method with a VERITY 4020 Syringe Pump, VERITY 4120 Syringe Pump, or VERITY 4220 Syringe Pump in the configuration.
2. Click **Run**.
3. Select a method under Method Configuration that includes the VERITY 4020 Syringe Pump, VERITY 4120 Syringe Pump, or VERITY 4220 Syringe Pump and then click .
4. Click  to access the Manual Control window.
5. Drag the Aspirate task from the Task/Command list and then drop it in the workspace. For the Aspirate Volume property, type the syringe capacity. Click **OK**.
6. Disconnect the syringe piston from the piston operating rod by unscrewing the piston holding screw on the underside of the rod.
7. Click **Run**.
8. After the syringe has been lowered, unscrew and remove the syringe from the valve.

TRILUTION® LH

The following procedures use TRILUTION LH software.

1. Open a method with a VERITY 4020 Syringe Pump, VERITY 4120 Syringe Pump, or VERITY 4220 Syringe Pump in the configuration.
2. Click **Run**.
3. Add a method to the sample list.
4. Select the Manual Control tab.
5. Select a method from the drop-down list of methods and then click **Go**. The instruments will initialize.
6. If using a VERITY® 4220 Dual Syringe Pump, select the syringe(s) that will be removed (Left Syringe and/or Right Syringe).
7. Disconnect the syringe piston from the piston operating rod by unscrewing the piston holding screw on the underside of the rod.
8. Click **Lower Syringe**.
9. After the syringe has been lowered, unscrew and remove the syringe from the valve.

Clean the Syringe

After the syringe has been removed, it can be cleaned:

1. Place the syringe in a beaker containing methanol, and then aspirate and dispense several volumes of methanol through the syringe.
2. Place the syringe in a beaker containing distilled or deionized water, and then aspirate and dispense several volumes of water through the syringe.
3. Hold the syringe housing in one hand. Clean the syringe using a non-abrasive cloth dampened with alcohol. Remove the piston and clean the piston with a non-abrasive cloth dampened with alcohol.
4. Dry the syringe and piston using a clean, lint-free cloth.

Reinstall the Syringe

TRILUTION® LC

The following procedures use TRILUTION LC software.

When the syringe is clean, reinstall it:

1. Fully tighten the syringe into the valve.
2. Click  to select the parameters and then home the syringe and valve.
3. Firmly tighten the piston holding screw to secure the syringe piston.

TRILUTION® LH

The following procedures use TRILUTION LH software.

When the syringe is clean, reinstall it:

1. Fully tighten the syringe into the valve.
2. Click **Raise Syringe**.
3. Firmly tighten the piston holding screw to secure the syringe piston.

Valve

Clean the syringe pump valve with a nonabrasive cloth after any of the following situations have occurred:

- Corrosive or hazardous liquids have been pumped
- Possible back flow of liquids into the waste tubing
- Leakage
- System has not been used for a while

If the valve sticks, first try using the valve key (part number F123674) to turn the valve axle to possibly free the valve.

Remove the Valve

To clean the valve, first remove it from the syringe pump:

1. Disconnect all tubing from the valve.
2. Disconnect the syringe from the valve. Refer to the procedure for replacing the syringe on page 31.
3. Remove the two screws securing the valve to the syringe pump and then remove the valve.

Disassemble the Valve

1. Hold the valve body firmly in one hand. Using a 17 mm open-ended wrench, turn the valve axle guide counterclockwise and separate the two halves.
2. Pull the valve axle away from the valve main body.
3. Separate the ceramic stator from the ceramic rotor.

NOTE

Do not remove the ceramic stator from the valve main body.

4. Tap the valve axle guide against a solid level surface to remove the spring and PTFE end piece.

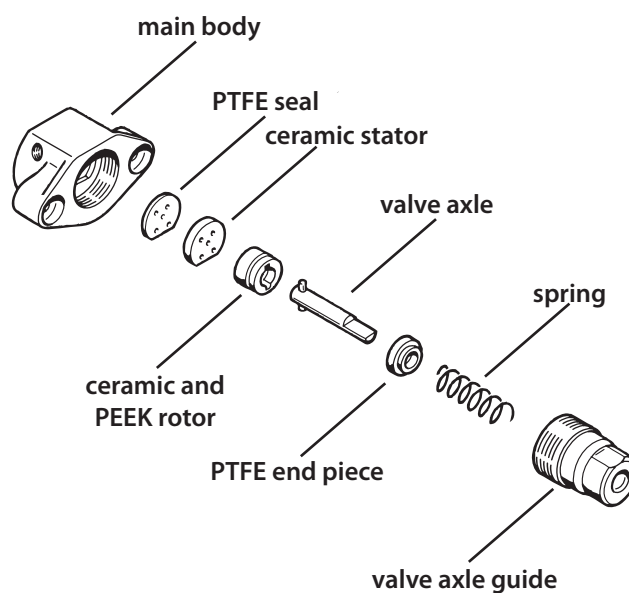

Figure 17: Valve (Disassembled)

Clean and Reinstall the Valve

1. Clean the disassembled parts of the valve using a non-abrasive cloth dampened with alcohol or by autoclaving.
2. Dry the components using a clean, lint-free cloth.
3. Reassemble the valve parts by reversing the above procedure.
4. Fully tighten the valve screws to secure the valve on the syringe pump.
5. Reinstall the syringe. Refer to the procedure for installing a new syringe on page 38.
6. Reconnect all tubing.

Tee

Clean the syringe pump tee with a nonabrasive cloth after any of the following situations have occurred:

- Corrosive or hazardous liquids have been pumped
- Possible back flow of liquids into the waste tubing
- Leakage
- Pump has not been used for a while

Remove the Tee

To clean the tee, first remove it from the syringe pump:

1. Disconnect the syringe from the tee.
2. Remove the tee from the front panel by removing the two securing screws.

Clean and Reinstall the Tee

1. Clean the tee using a non-abrasive cloth dampened with alcohol or by autoclaving.
2. Dry the tee using a clean, lint-free cloth.
3. Reinstall the syringe and tee.

Part Replacement

Refer to the instructions in this section to replace the:

- **Tubing** on page 36
- **Syringe** on page 36
- **Valve** on page 38

Tubing

It is important to keep all tubing clean and free of crimps. Tubing that has become dirty, blocked, or crimped can result in poor accuracy and precision, or loss of air gap.

Replace both the transfer tubing and inlet tubing as needed. Refer to the [Replacement Parts and Accessories](#) appendix starting on page 45 for part numbers for replacement tubing. For tubing installation procedures, refer to [Plumbing Connections](#) on page 19.

Syringe

If necessary, refer to the diagram below while performing the procedures in this section.

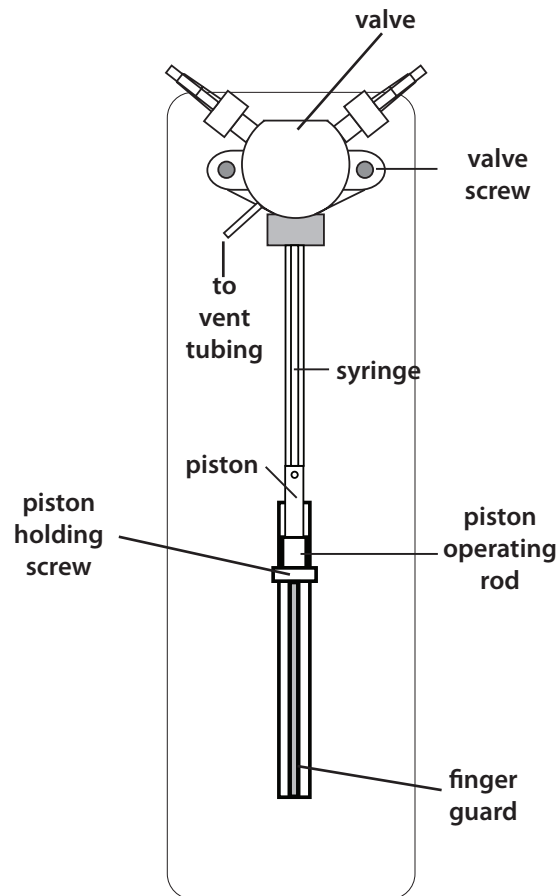



Figure 18: Syringe Diagram

Remove the Syringe

TRILUTION® LC

The following procedures use TRILUTION LC software.

1. Open a method with a VERITY 4020 Syringe Pump, VERITY 4120 Syringe Pump, or VERITY 4220 Syringe Pump in the configuration.
2. Click **Run**.
3. Select a method under Method Configuration that includes the VERITY 4020 Syringe Pump, VERITY 4120 Syringe Pump, or VERITY 4220 Syringe Pump and then click .
4. Click  to access the Manual Control window.
5. Drag the Aspirate task from the Task/Command list and then drop it in the workspace. For the Aspirate Volume property, type the syringe capacity. Click **OK**.
6. Disconnect the syringe piston from the piston operating rod by unscrewing the piston holding screw on the underside of the rod.
7. Click **Run**.
8. After the syringe has been lowered, unscrew and remove the syringe from the valve.

TRILUTION® LH

The following procedures use TRILUTION LH software.

1. Open a method with a VERITY 4020 Syringe Pump, VERITY 4120 Syringe Pump, or VERITY 4220 Syringe Pump in the configuration.
2. Click **Run**.
3. Add a method to the sample list.
4. Select the Manual Control tab.
5. Select a method from the drop-down list of methods and then click **Go**. The instruments will initialize.
6. If using a VERITY 4220 Syringe Pump select the syringe(s) that will be removed (Left Syringe and/or Right Syringe).
7. Disconnect the syringe piston from the piston operating rod by unscrewing the piston holding screw on the underside of the rod.
8. Click **Lower Syringe**.
9. After the syringe has been lowered, unscrew and remove the syringe from the valve.

Install the New Syringe

TRILUTION® LC

The following procedures use TRILUTION LC software.

1. Fully tighten the syringe into the valve.
2. Click  to select the parameters and then home the syringe and valve.
3. Firmly tighten the piston holding screw to secure the syringe piston.

TRILUTION® LH

The following procedures use TRILUTION LH software.

1. Fully tighten the syringe into the valve.
2. Click **Raise Syringe**.
3. Firmly tighten the piston holding screw to secure the syringe piston.

Valve

To replace a valve on the syringe pump, follow the instructions below. If necessary, refer to the syringe pump diagram at right.

1. Disconnect the inlet, transfer, and vent tubing from the valve.
2. Disconnect the syringe from the syringe pump. Refer to the procedure for replacing the syringe on page 36.
3. Remove the two screws securing the valve to the syringe pump and then remove the valve.
4. Position the replacement valve and then fully tighten the valve screws to secure it.
5. Reinstall the syringe. Refer to the procedure for installing a new syringe on page 38.
6. Reconnect all tubing.

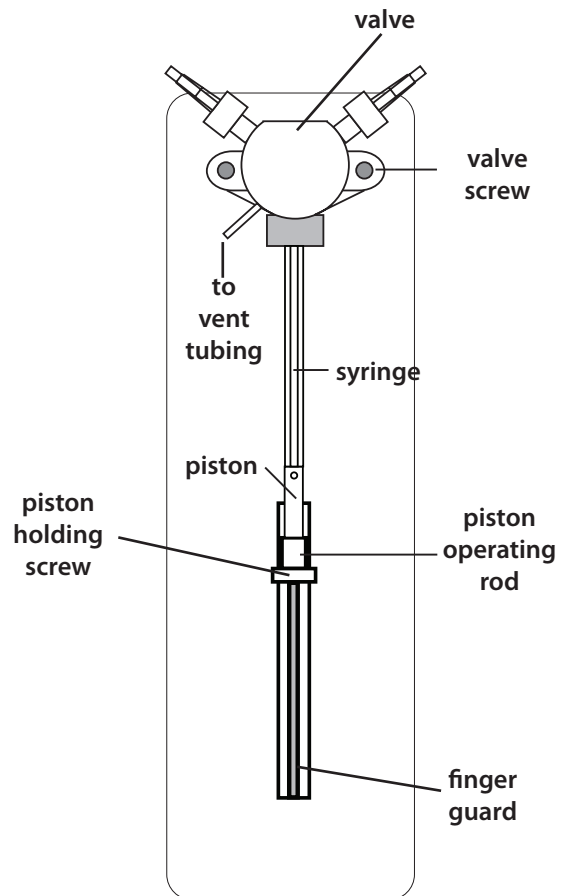

Figure 19: Syringe Diagram

Troubleshooting

Chapter Five

This chapter provides information on the following topics:

- **Mechanical** on page 40
- **Electrical** on page 40
- **Hydraulic** on page 40
- **Error Codes and Messages** on page 42
- **Repair and Return Policies** on page 44

Mechanical

<i>Problem</i>	<i>Solution</i>
Valve does not fit on the syringe pump	Valve axle not properly aligned with the motor drive; ensure that the flat on the axle is aligned with the drive slot on the motor
Valve moves during aspirate or dispense	Valve mounting screw not tight; check that the mounting screws, syringe, and syringe mounting screw are all tight
Valve sticks	Clean the valve (refer to the instructions on page 34)

Electrical

<i>Problem</i>	<i>Solution</i>
Syringe pump does not respond	<p>Make sure power is turned on</p> <p>Check cabling connections</p> <p>Unplug the USB cable and then reconnect in a different port on the PC</p> <p>Try a different AC outlet</p> <p>Restart the PC</p>

Hydraulic

<i>Problem</i>	<i>Solution</i>
Liquid leakage	Make certain all fittings are tight
Liquid leaving by the vent	<p>If tubing is kinked or blocked, replace tubing</p> <p>Ensure that the inlet tubing is clear</p> <p>Dirt may be trapped between the ceramic surfaces; clean the valve (instructions on page 34)</p>
Instrument will not draw in solvent	<p>Make certain all fittings are tight</p> <p>Check valve fitting threads on the syringe pump and replace if damaged</p>
No fluid being dispensed	<p>Make sure the syringe is tight within the valve fitting</p> <p>If tubing is kinked or blocked, replace defective tubing</p> <p>Replace the syringe pump valve if damaged</p>
Air gap breaks up	<p>When aspirating a liquid, if the air gap breaks up, check to see if the tubing is the correct size</p> <p>Reduce aspirate flow rate</p> <p>Increase volume of air gap</p> <p>Clean or replace any dirty tubing</p>

<i>Problem</i>	<i>Solution</i>
Syringe bubbles	<p>Make sure that all fittings are tight and air-free</p> <p>Make sure the syringe is tightened into the valve</p> <p>Clean the syringe if dirty (instructions on page 31)</p> <p>If any of the valve fittings are damaged, replace the valve</p>
Fluid leak	<p>Allow solvents to warm to room temperature before using</p> <p>Clean valve (instructions on page 34)</p> <p>Replace the syringe piston seal</p>
Incorrect aspirating and dispensing	<p>Check for leaks on all fittings</p> <p>Tighten or replace fittings on inlet and transfer tubing as needed</p> <p>Replace the valve if damaged</p> <p>Clean or replace transfer tubing</p>
Syringe stalls	<p>If the syringe stalls, inspect the tubing and valve for a blockage</p> <p>If the syringe stalls due to an accelerated aspirate or dispense rate, reduce the rate in the software</p>
Poor accuracy	<p>Clean or replace any dirty tubing</p> <p>Replace the syringe piston seal</p> <p>If the aspirate and dispense speeds are too fast, slow down the speeds to adapt to the tubing and probe type</p>

Error Codes and Messages

To obtain the error code and message, view the log file produced during the run.

TRILUTION® LC

To display the log file produced during a run:

1. Access the Results dialog by right-clicking on an application in the Project Library and then selecting **Results** or by double-clicking the Results icon (R).
2. Locate the run for which you want to view the log.
3. Right-click on the run and then select **View Log**. The file appears in a text editor box.

TRILUTION® LH

To display the log file produced during a run:

1. Access the Run Results by clicking **Liquid Handling | Utilities | Run Results** or by clicking **Results** in the Application window.
2. Locate the run for which you want to view the log.
3. Click **View Log** or right-click on the run and then select **View Log**. The file appears in a text editor box.

Error Codes and Messages

Refer to the table below for a list of the error codes and messages.

<i>Error</i>	<i>Error Text</i>	<i>Error</i>	<i>Error Text</i>
0	No Error	26	Invalid Valve Position
10	Unknown Command	27	Invalid Syringe Pump Volume
11	Invalid NV-RAM Address	28	Invalid Valve Move Speed
12	Emergency Stop Activated	29	Invalid Syringe Pump Flow Rate
13	Bad Parameter Entered	30	Invalid Valve Type
16	Character Limit	31	Invalid Syringe Size
18	Valve Park Location	32	Invalid Valve Selection
19	Syringe Pump Park Location	33	Invalid Syringe Pump Selection
20	Valve Unhomed	34	Missing Valve Encoder
21	Syringe Pump Unhomed	35	Missing Syringe Pump Encoder
22	Valve Moving	36	Set Pressure Offset to Zero
23	Syringe Pump Moving	37	Other Syringe Module in Error
24	Valve Stall		
25	Syringe Pump Stall		

Repair and Return Policies

Refer to the following information and then contact your local Gilson representative. Specific contact information can be found at www.gilson.com.

Before Calling Us

Your local Gilson representative will be able to serve you more efficiently if you have the following information:

- serial number and model number of the instruments involved
 - The serial number is located on the right side of the syringe pump.
- installation procedure you used
- list of concise symptoms
- list of operating procedures and conditions you were using when the problem arose
- list of all instruments in the configuration and the connections to those instruments
- list of other electrical connections in the room

Warranty Repair

Units covered under warranty will be repaired and returned to you at no charge. If you have any questions about applicability, contact your local Gilson representative.

Non-Warranty Repair

For out-of-warranty repairs, contact your local Gilson representative who will discuss service options with you and can assist in making arrangements to return the equipment, if necessary.

Return Procedure

Contact your local Gilson representative to obtain authorization before returning any Gilson equipment. To return a piece of equipment:

- Carefully pack the unit to prevent damage in transit. Check with your local Gilson representative regarding proper method of shipment. No responsibility is assumed by Gilson or your local Gilson representative for damage caused by improperly packaged instruments. Indicate the authorization on the carton and on the packing slip.
- Always insure for the replacement value of the unit.
- Include a description of symptoms, your name, address, phone number, and purchase order to cover repair costs, return and shipping charges, if your institution requires it.

Unit End-of-Life

When a unit reaches the end of its useful life, refer to www.gilson.com for directions and information on the end-of-life policy. This is in accordance with the European Union Directive 2002/96/EC on Waste Electrical and Electronic Equipment (WEEE).



Replacement Parts and Accessories

Appendix A

Syringe Pumps

<i>Part Number</i>	<i>Description</i>
31130001	VERITY® 4020 Single Syringe Pump
31130002	VERITY® 4120 Dual with Tee Syringe Pump
31130003	VERITY® 4220 Dual Syringe Pump

Syringes

<i>Part Number</i>	<i>Description</i>
25025341	100 µL Syringe
25025342	250 µL Syringe
25025347	500 µL Syringe
25025343	1 mL Syringe
25025344	5 mL Syringe
25025345	10 mL Syringe
25025346	25 mL Syringe

Piston Seals

<i>Part Number</i>	<i>Description</i>
F4015062	Piston Seal for 100 µL Syringe (pkg of 5)
250253411	Sealing Cover for 100 µL Syringe (pkg of 5)
F4015063	Piston Seal for 250 µL Syringe (pkg of 5)
250253421	Sealing Cover for 250 µL Syringe and 500 µL Syringe (pkg of 5)
F4015064	Piston Seal for 500 µL Syringe (pkg of 5)
F4015065	Piston Seal for 1 mL Syringe (pkg of 5)
F4015066	Piston Seal for 5 mL Syringe
F4015067	Piston Seal for 10 mL Syringe
F4015068	Piston Seal for 25 mL Syringe

Valve and Valve Parts

<i>Part Number</i>	<i>Description</i>
27073510	Syringe Valve Assembly
27073511	Rotor (Ceramic)
27073512	Stator (Ceramic)
27073514	Seal
27073515	Spring
27073526	Ceramic Stator and Rotor Kit
F123674	Valve Key
49041019	Plug for Unused Ports
2502534811	Stainless Steel Thumbscrew for Syringe Piston

Tubing

Inlet

<i>Part Number</i>	<i>Description</i>
499484021	Inlet Tubing Assembly

Vent

<i>Part Number</i>	<i>Description</i>
F4420577	Vent Tubing

Junction (for VERITY® 4120 Syringe Pump only)

<i>Part Number</i>	<i>Description</i>
49960003	Junction Tubing, .030" ID x .062" OD x 4.0" FEP 46uL
49960004	Junction Tubing, .080" ID x .125" OD x 4.0" FEP 330uL

Cables and Power Cords

<i>Part Number</i>	<i>Description</i>
7080316106	Power Cord, 220V
7080318107	Power Cord, 110V
32000012	USB Cable

Materials

Appendix B

Liquid Contact Materials

The information provided in the following table is accurate to the best of our knowledge and belief, but is intended for general information only.

<i>Material</i>	<i>Description</i>
Ekonol	<p>Ekonol has excellent solvent resistance with the exception of concentrated sulfuric acid and strong alkalis. The water absorption rate is low at 0.4% after 500 hours at 212° F. Ekonol Polyester is self-lubricating and provides excellent friction and wears properties.</p> <p>Ekonol Polyester is a very thermally stable polymer, making it easy to blend/fabricate with other high temperature materials. When combined with polytetrafluoroethylene (i.e., PTFE); it produces a composite material that has excellent temperature and wear resistance properties. The Ekonol Polyester/PTFE blend will not wear metal surfaces and resists self-wear better than any other PTFE composition. Applications for Ekonol Polyester/PTFE blends are varied and include packing sets, compressor ring sets, "O" ring seals, spring-loaded seals, lip seals, self-lubricating bearings and rotors or vanes of process pumps. Ekonol Polyester/PTFE works best under environmentally tough conditions where wear resistance, dimensional stability and corrosion resistance are critical.</p>
FEP	<p>Fluorinated ethylene propylene is another member of the fluorocarbon family with similar chemical properties. It is generally more rigid than PTFE, with somewhat increased tensile strength. It is typically more transparent than PTFE, slightly less porous, and less permeable to oxygen. FEP is not as subject to compressive creep at room temperature as PTFE, and because of its slightly higher coefficient of friction is easier to retain in a compression fitting.</p>

Liquid Contact Materials (Continued on page 50)

<i>Material</i>	<i>Description</i>
PEEK	<p>Considered relatively inert and biocompatible, polyetheretherketone tubing can withstand temperatures up to 100°C. Under the right circumstances, 0.005"–.020" ID tubing can be used up to 5000 psi for a limited time, and 0.030" to 3000 psi. Larger IDs are typically good to 500 psi. These limits will be substantially reduced at elevated temperatures and in contact with some solvents or acids.</p> <p>Its mechanical properties allow PEEK to be used instead of stainless in many situations and in some environments where stainless would be too reactive. However, PEEK can be somewhat absorptive of solvents and analytes, notably methylene chloride, DMSO, THF, and high concentrations of sulfuric and nitric acid. This tubing is highly prone to “kinking,” or sealing off, if held in a sharp bend over time.</p>
PTFE	<p>Polytetrafluoroethylene is the generic name for the class of materials such as Teflon®. It offers superior chemical resistance but is limited in pressure and temperature capabilities. Because it’s so easy to handle, it is often used in low pressure situations where stainless steel might cause adsorption. PTFE tubing is relatively porous, and compounds of low molecular weight can diffuse through the tubing wall.</p>
PVDF	<p>PVDF, polyvinylidene fluoride, has excellent resistance to most mineral and organic acids, aliphatic and aromatic hydrocarbons, and halogenated solvents. Poor resistance to acetone, MEK, THF, and potassium and sodium hydroxide. Often supplied as Kynar®.</p>

FEP, PEEK, PTFE, and PVDF descriptions provided by Valco Instruments Company Inc (www.vici.com).

Ekonal description provided by Saint-Gobain Coating Solutions (www.coatingsolutions.saint-gobain.com)

Operational Description

Appendix C

Refer to the text and diagrams in this appendix for information about how liquid is aspirated and dispensed, depending on the configuration:

- [VERITY® 4020 Single Syringe Pump](#) on page 52
- [VERITY® 4120 Dual with Tee Syringe Pump](#) on page 53
- [VERITY® 4220 Dual Syringe Pump](#) on page 58

VERITY® 4020 Single Syringe Pump

The VERITY® 4020 Syringe Pump has a single syringe and valve. The instrument only dispenses to the probe. (It is impossible to dispense to the reservoir.)

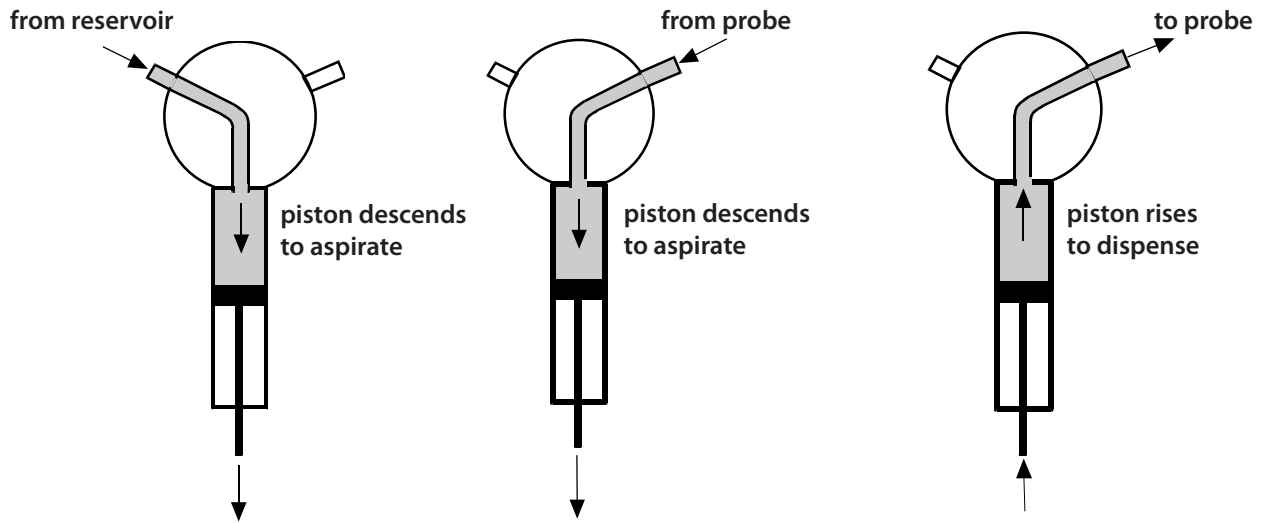

Figure 20: Aspirating from Reservoir

Figure 21: Aspirating from Probe

Figure 22: Dispensing

When aspirating from the probe, it is important to take into account the volume of transfer tubing connecting the pump outlet to the probe. The liquid aspirated from the probe must never enter the valve. The maximum volume of liquid that can be aspirated from the probe is limited to the volume of the syringe, or the volume of the transfer tubing, whichever is smaller.

VERITY® 4120 Dual with Tee Syringe Pump

The instrument should be configured with a large syringe on the left (mounted on the valve) and a small syringe, or equal volume, on the right (mounted on the tee). This allows large volumes to be dispensed quickly from the left syringe or smaller volumes to be dispensed with a high degree of accuracy from the right syringe.

In general, the left syringe is used for dispensing or for transferring sample liquids when the sample volume to be transferred is greater than the volume of the right syringe.

NOTE

It is impossible to dispense to the reservoir with either syringe.
It is impossible to aspirate from the reservoir with the right syringe.
When aspirating from the probe, it is important to take into account the volume of transfer tubing connecting the pump outlet to the probe. The liquid aspirated from the probe must never enter the valve or either of the syringes.
The maximum volume of liquid that can be aspirated from the probe is limited to either the volume of the syringe that is used to aspirate, or the volume of the transfer tubing, whichever is smaller.

The left syringe can aspirate from the reservoir or the probe. It can only dispense to the probe. The right syringe can only directly aspirate from and dispense to the probe.

Aspirating from the Reservoir (Left Syringe Only)

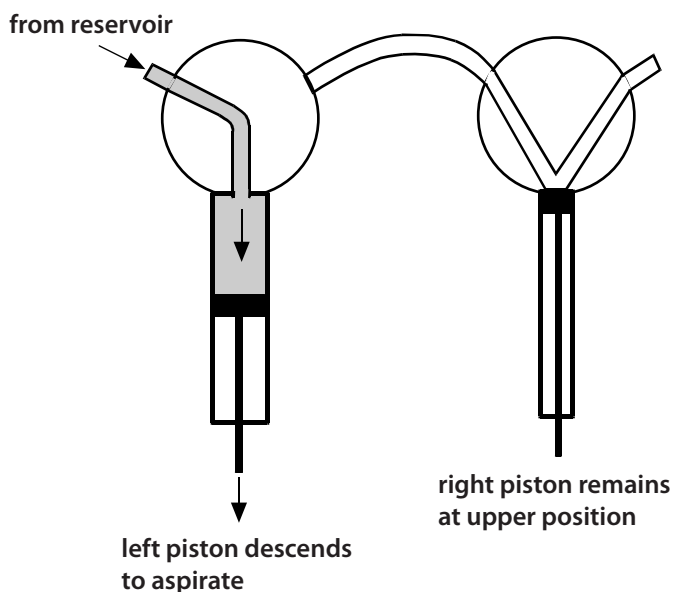

Figure 23: Aspirating from the Reservoir (Left Syringe Only)

The valve switches to connect the left syringe to the reservoir.

The piston of the right syringe remains in the top position.

The left syringe descends to aspirate the specified volume.

It is impossible to aspirate from the reservoir with the right syringe.

Dispensing from the Left Syringe

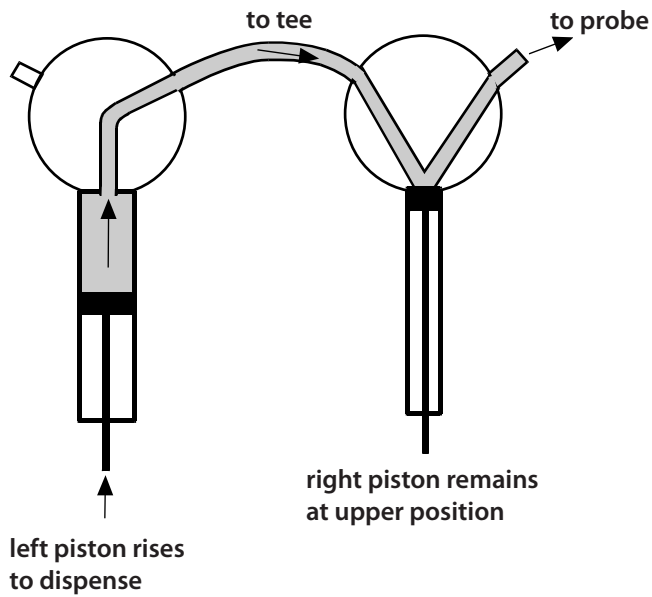

Figure 24: Dispensing from the Left Syringe

The valve switches to connect the left syringe to the tee and probe.

The piston of the right syringe remains in the top position to prevent liquid from entering the syringe.

The left syringe raises to dispense the specified volume.

It is impossible to dispense to the reservoir with either syringe.

Dispensing from the Right Syringe

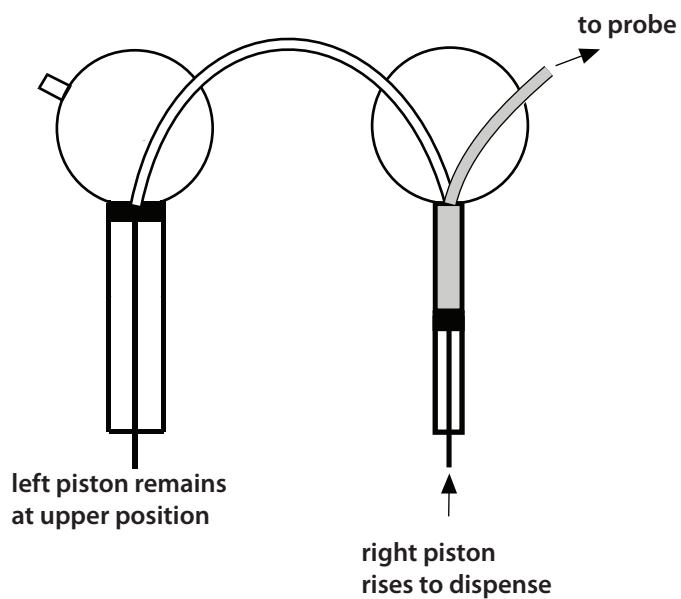

Figure 25: Dispensing from the Right Syringe

The valve switches to connect the right syringe to the tee and probe.

The piston of the left syringe remains in the top position to prevent liquid from entering the syringe.

The right syringe raises to dispense the specified volume.

It is impossible to dispense to the reservoir with either syringe.

Aspirating from the Probe (Left Syringe)

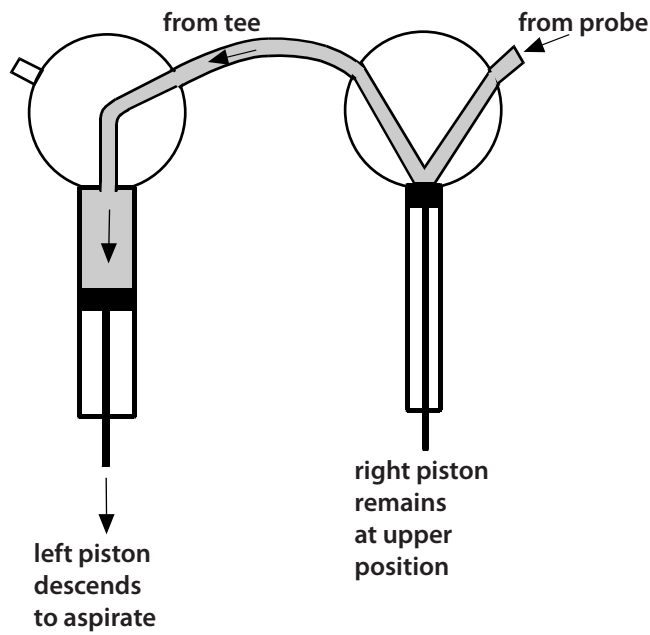

Figure 26: Aspirating from the Probe (Left Syringe)

The valve switches to connect the left syringe to the tee and probe.

The piston of the right syringe remains in the top position to prevent liquid from entering the syringe.

The left syringe descends to aspirate the specified volume of sample liquid.

Aspirating from the Probe (Right Syringe)

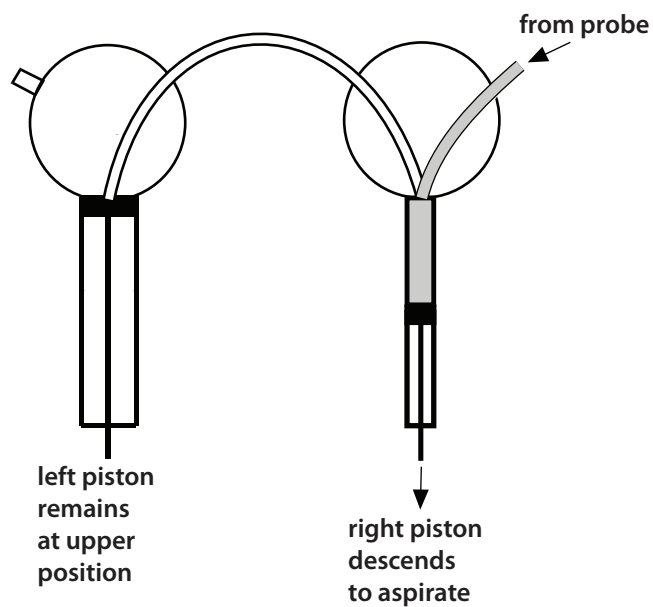

Figure 27: Aspirating from the Probe (Right Syringe)

The valve switches to connect the right syringe to the probe.

The piston of the left syringe remains in the top position to prevent liquid from entering the syringe.

The right syringe descends to aspirate the specified volume of sample liquid.

VERITY® 4220 Dual Syringe Pump

The VERITY® 4220 Dual Syringe Pump is equipped with up to two syringes that are user-selectable, can be the same or different, and can be a small- or large-capacity. Two valves direct liquid from reservoirs or up to two probes. When two VERITY® 4220 Dual Syringe Pumps are used with a GX-274 Liquid Handler, up to four fluid paths can be controlled and monitored independently, which allows for a high throughput configuration capable of processing up to four samples in parallel.

The right syringe and valve functions in the same way as the left syringe and valve.

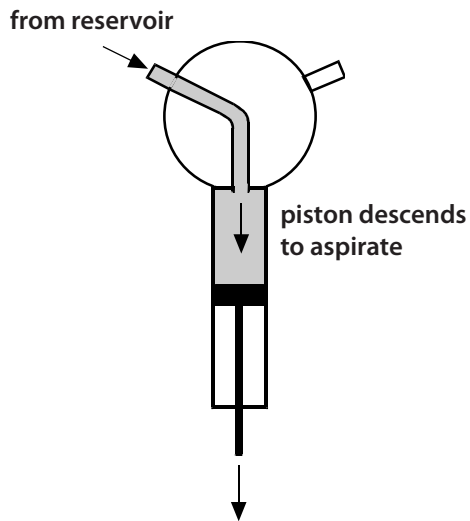

Figure 28: Aspirating from Reservoir

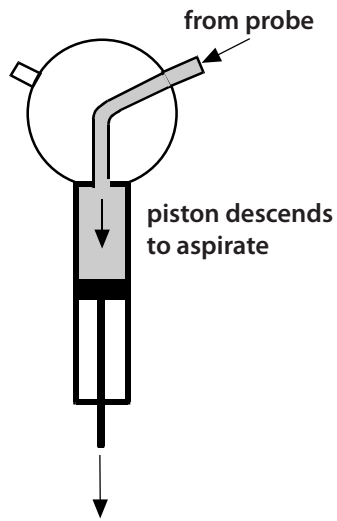

Figure 29: Aspirating from Probe

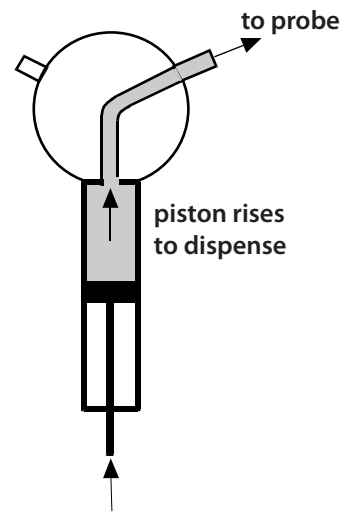

Figure 30: Dispensing